

High-Repetition-Rate Lasers



FLINT-FL1

From 10 to 100 MHz repetition rate

Down to 50 fs pulse duration

High-power models, up to 20 W

High-energy energy models, up to 0.5 μ J

Industrial-grade design for high output stability

CEP stabilization or repetition rate locking

FLINT-FL1
Typical spectrum

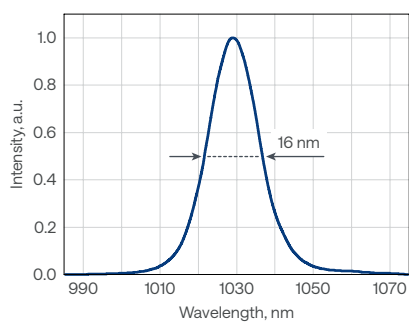

FLINT-FL1
Typical pulse duration

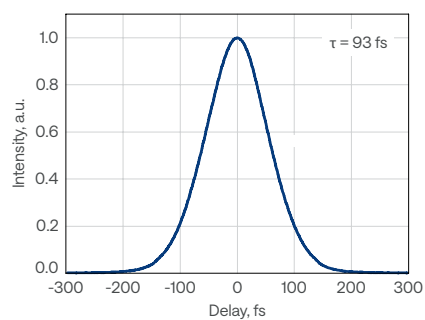

FLINT-FL1
Typical beam profile

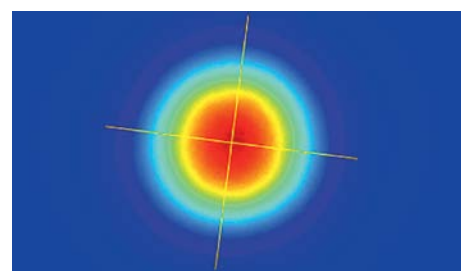

FLINT-FL2-SP
Typical spectrum

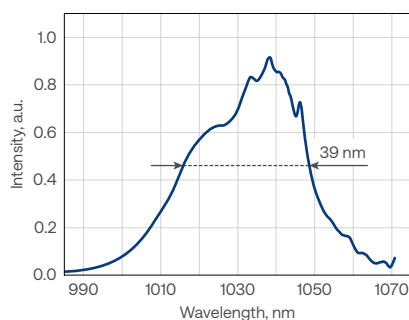

FLINT-FL2-SP
Typical pulse duration

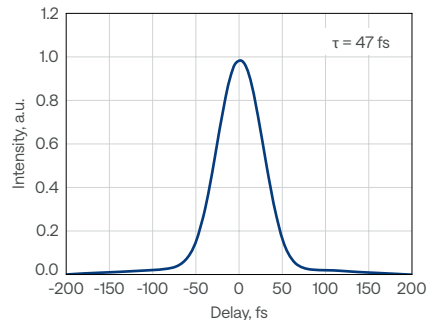

FLINT-FL2-SP
Typical beam profile

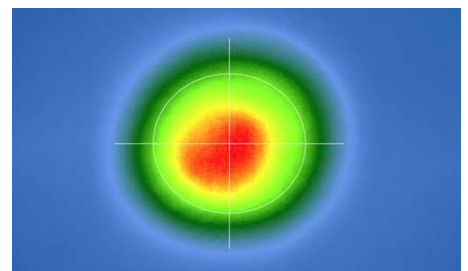

Specifications

Model	FL1			FL2-SP	FL2		
Key feature	CEP	RRL	Compact	Short pulse	High power and high energy		
Pulse duration	< 100 fs		< 120 fs	< 50 fs	< 120 fs	< 170 fs ¹⁾	
Repetition rate	60 – 100 MHz ²⁾			10 MHz	10 MHz	40 MHz	80 MHz
Maximum output power	0.5 W	1 W	8 W	4 W	5 W	20 W	
Maximum pulse energy	6 nJ ³⁾	12.5 nJ ³⁾	100 nJ ³⁾	0.4 μJ	0.5 μJ		0.25 μJ
Center wavelength	1035 ± 10 nm			1030 ± 10 nm	1030 ± 10 nm		
Polarization	Linear, horizontal						
Beam quality, M ²	< 1.2			< 1.3	< 1.2		
Beam pointing stability	< 10 μrad/°C						
Long-term power stability, 100 h ⁴⁾	< 0.5%						
Integrated 2H generator ⁵⁾	n/a				Optional; conversion efficiency > 30% ⁶⁾ ; see page 21		
External 2H, 3H, or 4H generator ⁵⁾	Optional; see page 24						
Integrated attenuator	n/a			Included			

PHYSICAL DIMENSIONS

Laser head (L × W × H)	448 × 206 × 115 mm	543 × 322 × 146 mm
Power supply and chiller rack (L × W × H)	642 × 553 × 540 mm	642 × 553 × 673 mm
Chiller	Different options available. Contact sales@lightcon.com	

ENVIRONMENTAL AND UTILITY REQUIREMENTS

Operating temperature	15 – 30 °C (air conditioning recommended)	
Relative humidity	< 80% (non-condensing)	
Electrical requirements	100 V AC, 7 A – 240 V AC, 3 A; 50 – 60 Hz	100 V AC, 12 A – 240 V AC, 5 A; 50 – 60 Hz
Rated power	200 W	
Power consumption	Laser	100 W
	Chiller	600 W
		150 W
		1000 W

¹⁾ For 20 W output power. Lower power models: 8 W and 12 W, are available upon request.

²⁾ Standard repetition rate is 80 MHz; custom repetition rate can be factory preset from the given range.

³⁾ Depends on the repetition rate. Values are given for 80 MHz.

⁴⁾ With enabled power-lock, under stable environmental conditions. Expressed as normalized root mean squared deviation (NRMSD).

⁵⁾ For external 2H, or even 3H and 4H generation, refer to HIRO for FLINT.

⁶⁾ Conversion efficiency specified at maximum power.

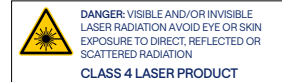

Stability

FLINT-FL2 (20 W) output power stability under harsh environmental conditions over 7 days

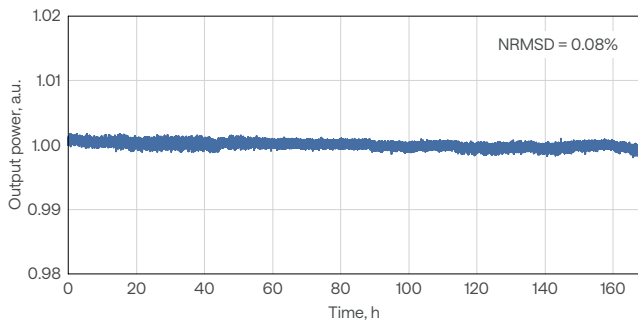

FLINT oscillator relative intensity noise (RIN), shot-noise limited at -160 dBc/Hz above 1 MHz

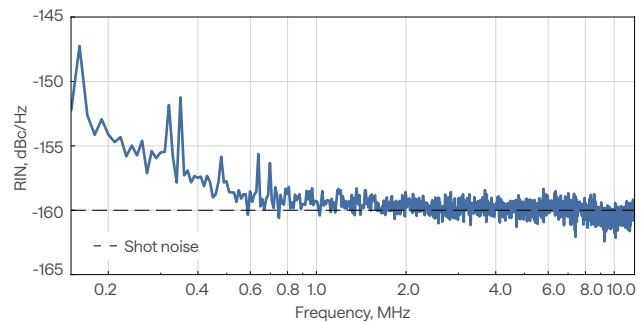

CEP stabilization

FLINT oscillators can be equipped with feedback electronics for carrier-envelope phase (CEP) stabilization of the output pulses. The carrier-envelope offset (CEO) of the oscillator is actively locked to $1/4^{\text{th}}$ of the repetition rate with a < 100 mrad standard deviation.

CEP-locked FLINT oscillator phase noise data

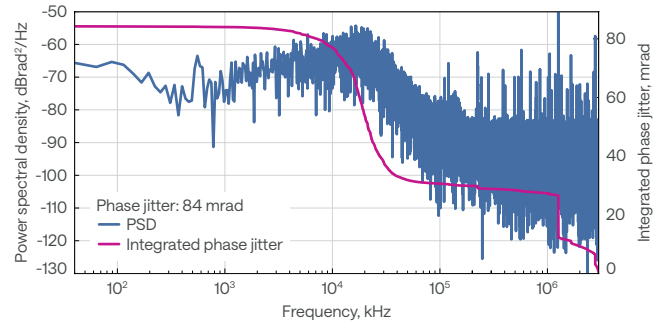

Repetition rate locking

FLINT oscillators are customizable for repetition rate locking applications. Coupled with the necessary feedback electronics, the repetition rate can be synchronized to an external RF source using the two piezo stages installed inside the cavity.

The repetition rate locking system can assure an integrated timing jitter of less than 200 fs for RF reference frequencies larger than 500 MHz. Continuous phase shifting is available upon request.

FLINT oscillator phase noise data locked to a 2.8 GHz RF source

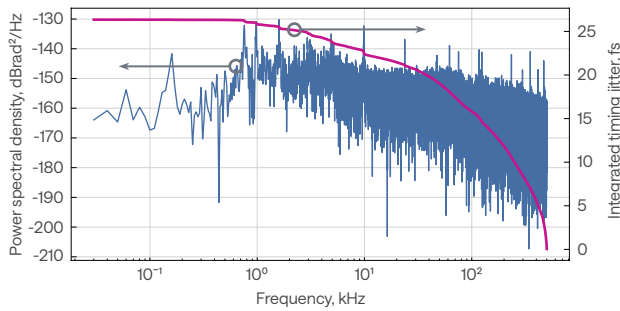

Timing jitter stability over 14 h:
FLINT oscillator locked to a 2.8 GHz RF source

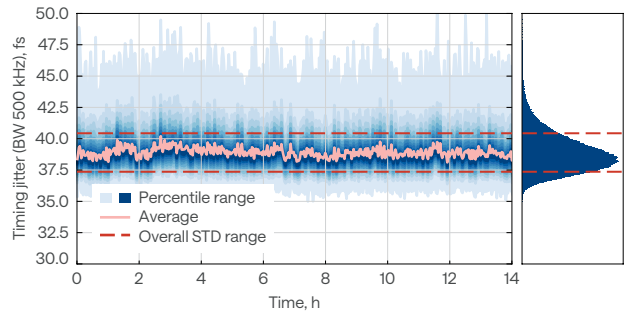

Drawings

FLINT-FL1 drawing

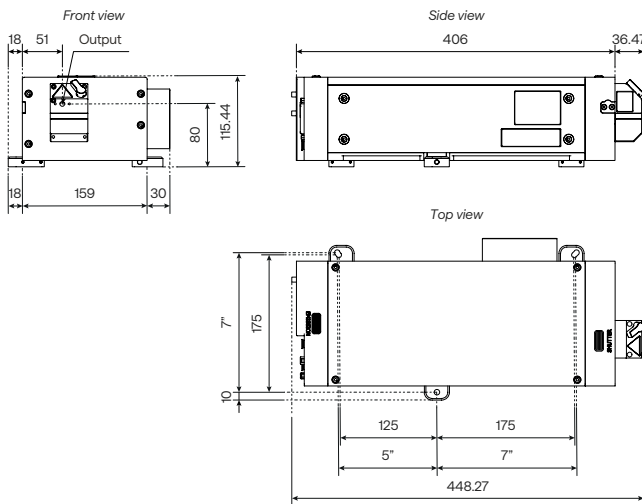

FLINT-FL2 drawing

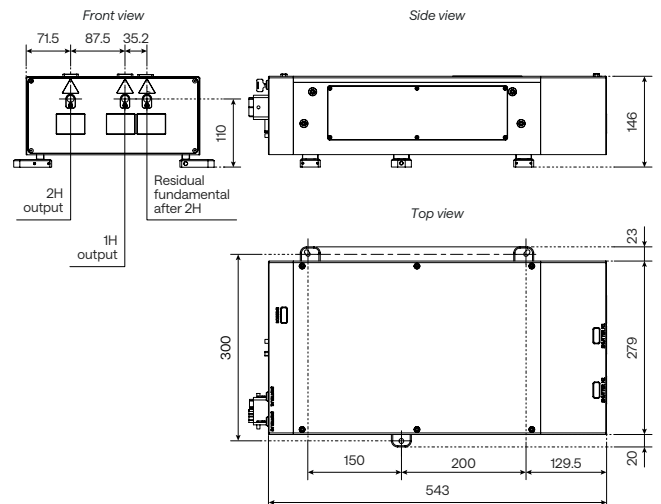

Second Harmonic Generator



FLINT-FL2 with integrated HG

515 nm output

Automated harmonic selection

Integrated into the housing

Industrial-grade design

Specifications

Model	FL1	FL2-SP	FL2		
Available harmonic	Refer to HIRO; see page 24		2H		
Pump repetition rate			10 MHz	40 MHz	80 MHz
Maximum pump power			5 W	20 W	
Center wavelength			515 ± 10 nm		
Conversion efficiency ¹⁾			> 30%		
Polarization			Linear, horizontal		

¹⁾ Conversion efficiency specified at maximum power.

